

BOTTOM - 60"

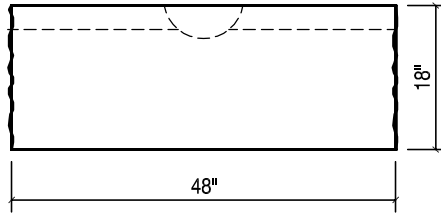

VOLUME: 22.20 CF
 WEIGHT: 3108 LBS
 CENTER OF GRAVITY: 26.53 IN

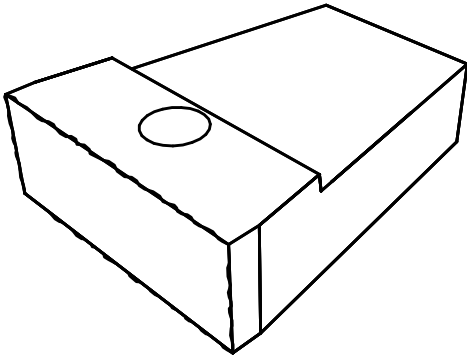

FRONT VIEW

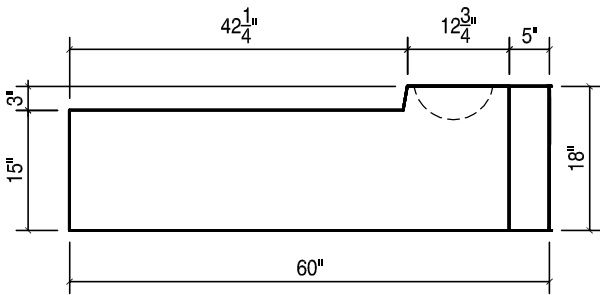

LEFT END VIEW

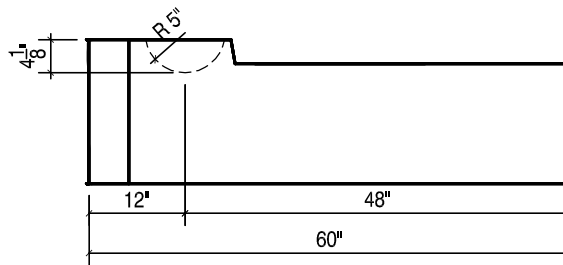

RIGHT END VIEW

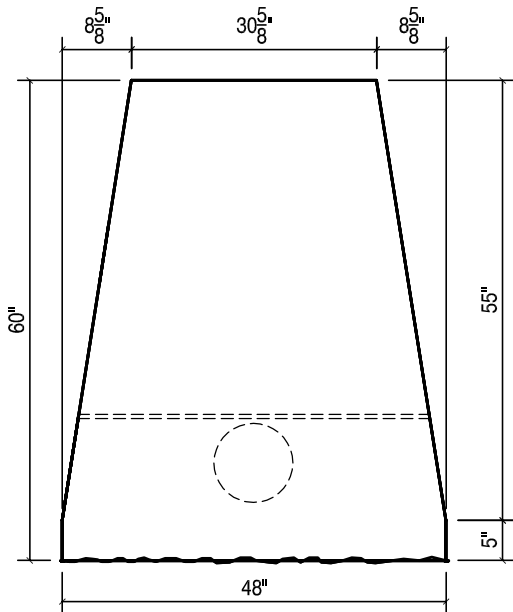

BOTTOM VIEW

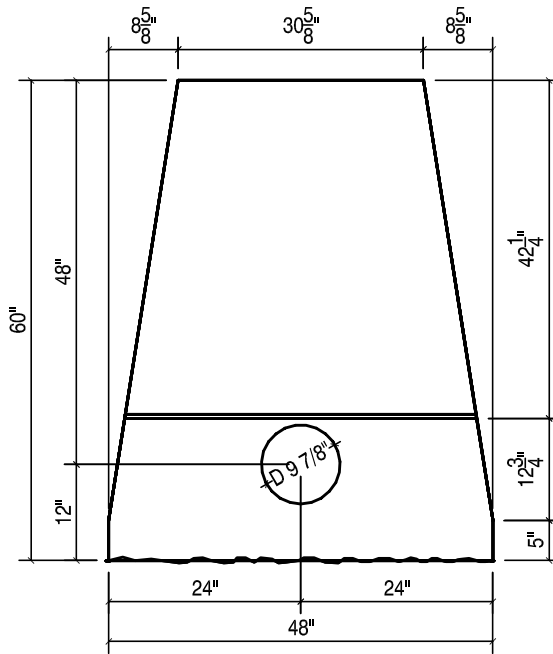

TOP VIEW

BLOCK PROPERTIES

NOTES:

1. VOLUME CALCULATIONS ARE BASED ON BLOCK AS SHOWN.
2. CENTER OF GRAVITY MEASURED FROM FRONT FACE OF BLOCK.
3. WEIGHT IS BASED ON 140 PCF CONCRETE.
4. ACTUAL WEIGHT, VOLUME AND CENTER OF GRAVITY CAN VARY.
5. CHECK WITH LOCAL BIG BLOCK REPRESENTATIVE FOR AVAILABILITY OF BLOCK AS SHOWN.